

Development of Validation Procedures for Automotive Anechoic Chambers from 1 GHz – 6 GHz

B.Sc. Michael Trischitz, Seibersdorf Labor, Austria
DI Dr. Alexander Kriz, Seibersdorf Labor, Austria

1 Introduction

Over the years, EMC standards have come to require stricter limits and higher frequency ranges for a variety of tests. Therefore, the test environment must be constructed and validated to meet the demands for higher frequency ranges. In December 2021, Edition 5.0 of the international standard CISPR 25 for “Vehicles, boats and internal combustion engines – Radio disturbance characteristics – Limits and methods of measurement for the protection of on-board receivers” was published. Since then, the standard requires emission measurements of components and modules from 150 kHz – 5.925 GHz. On the other hand, the test site validation procedure described in CISPR 25 is only specified from 150 kHz – 1 GHz [1]. Therefore, most automotive products are tested in frequency ranges which exceed the upper frequency limit of the accredited validated Absorber Lined Shielded Enclosures (ALSEs). In this scientific work, two site validation procedures are developed and investigated. The simulation method and the reference measurement method.

2 Validation Procedures

2.1 Validation Setup

Both procedures share the same measurement setup and instrumentation to ensure comparability. The validation setup is similar to the measurement setup for emission tests described in CISPR 25 [1]. Instead of an automotive product, a conical dipole antenna is placed on the reference ground plane as transmission source. The measurement is performed in horizontal and in vertical antenna polarization, see Figure 1 and Figure 2 respectively.

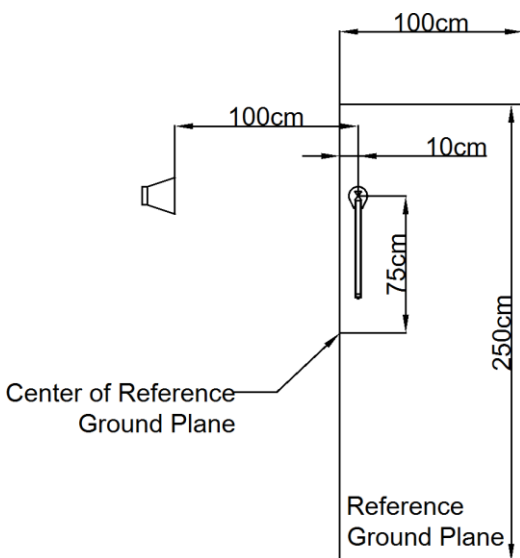

Figure 1: Measurement setup for ALSE validation 1 GHz – 6 GHz, horizontal antenna polarization, top view

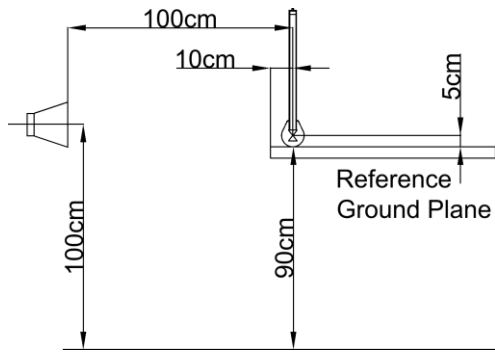

Figure 2: Measurement setup for ALSE validation 1 GHz – 6 GHz, vertical antenna polarization, side view

As transmit antenna, the Seibersdorf Labor POD16 antenna is used. The antenna is designed for the frequency range from 1 GHz up to 6 GHz and consists of a conical dipole, fed by a semi-rigid cable inside the antenna stem. The feeding cable is aligned through the center of one cone and connected to the phase center of the dipole, see Figure 3. Therefore, the influence of the feeding cable on the radiation pattern of the antenna is decreased [2].

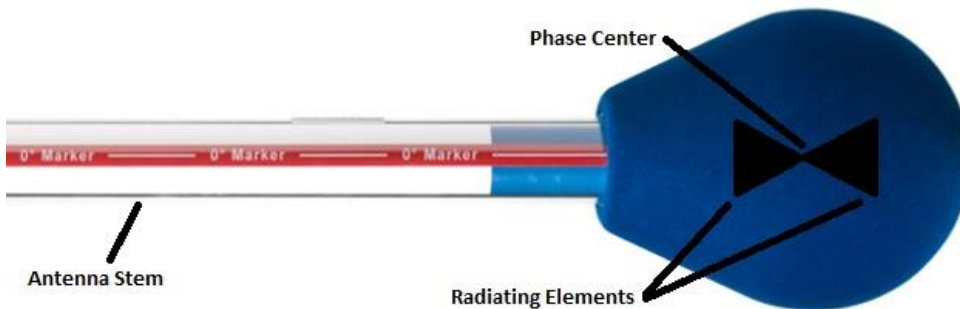

Figure 3: Schematic illustration of the transmit antenna

2.2 Evaluation Principle

For both validation procedures, the maximum equivalent field strength inside an ALSE is observed and compared to the maximum equivalent field strength from the reference measurement or the reference simulation. The equivalent field strength is the field strength that would be received, when a signal of 1 V is injected in the input of the dipole antenna. The equivalent field strength is calculated by equation (1) [1]. The calculation of the equivalent field strength is done for both antenna polarizations and the maxima values are used to obtain the maximum equivalent field strength of a test site $E_{eq,max}$. The deviation between the maximum equivalent field strength inside the ALSE and the respective reference field strength must be within ± 6 dB, similar to the performance limit described in CISPR 25 [1].

$$E_{eq}[dB(\mu V/m)] = 120 [dB(\mu V)] + (M_A[dB(\mu V)] - M_0[dB(\mu V)]) + k_{AF}[dB(1/m)] \quad (1)$$

With:

- E_{eq} equivalent field strength
- M_A receiver reading when the cables are connected to their respective antennas
- M_0 receiver reading when the cables are connected to each other
- k_{AF} antenna factor of receive horn antenna

2.3 Simulation Method

The simulation method is similar to the existing “Long Wire Method” for ALSE validation below 1 GHz described in CISPR 25, where the equivalent field strength inside an ALSE is compared to simulation data [1]. The measurement setup and instrumentation are adapted for the higher frequency range, see Figure 4. The simulation model is explained further in Section 3. To determine the influence of a test site, the modeled reference field strength is deducted from the measured maximum equivalent field strength.

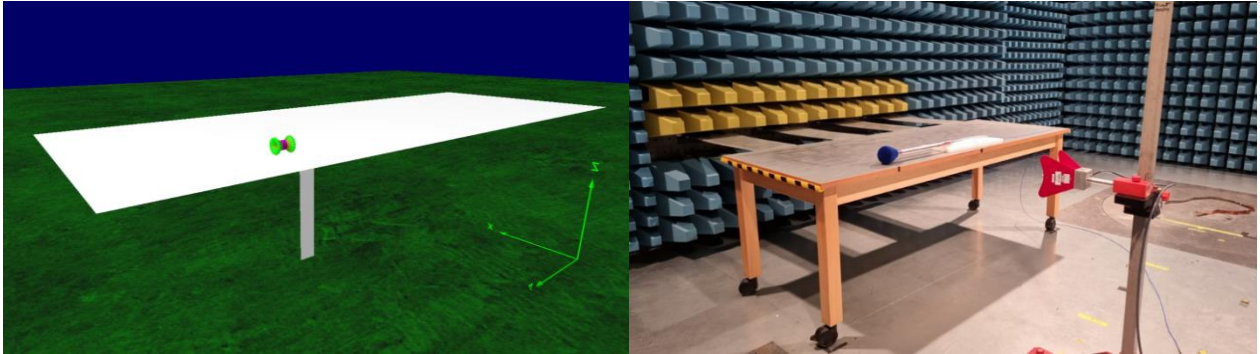

Figure 4: Simulation model and validation setup inside ALSE, horizontal antenna polarization

2.4 Reference Measurement Method

For the reference measurement method, the same measurement with the same equipment is performed on an Open Area Test Site (OATS) to obtain reference data before the measurement is performed inside an ALSE, see Figure 5. Afterwards, the measured maximum equivalent field strength on an OATS is deducted from the maximum equivalent field strength inside an ALSE. The procedure is similar to the procedure described in “An Accurate Validation Procedure for Component Testing Chambers” [3]. Further, the reference data on the OATS is used to ensure if the validation model for the simulation method is accurate.



Figure 5: Validation setup on OATS and inside ALSE, horizontal antenna polarization

3 Investigation of Simulation Model and Simulation Method

3.1 Simulation Model

The transmit antenna and the validation setup were modeled using the software 4NEC2 [4]. Initially, only the cones of the transmit antenna were modeled. The antenna factor of the simulation model was calculated and compared with the antenna factor of the transmit antenna to verify the plausibility of the validation setup model. Each cone of the dipole of the POD16 antenna is represented by 18 wires, each consisting of 11 segments. These wires are aligned to represent the surface area of the cones, see Figure 6. The influence of the semi rigid cable inside the antenna stem is reduced with absorbers and ferrite tiles. Therefore, the antenna stem is not modeled. However, the attenuation of the antenna stem was measured and considered for the calculation of the modeled reference field strength.

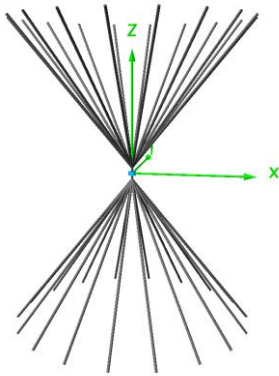

Figure 6: Simulation model of transmit antenna

Figure 7 shows that the traces of the measured antenna factor and the calculated antenna factor match. Therefore, the overall simulation model of the validation setup is credible. The highest deviation between both antenna factors is 1.63 dB at 1.45 GHz. The deviation affects the maximum modeled reference field strength of the validation setup and is observable in the evaluation of the test site as well.

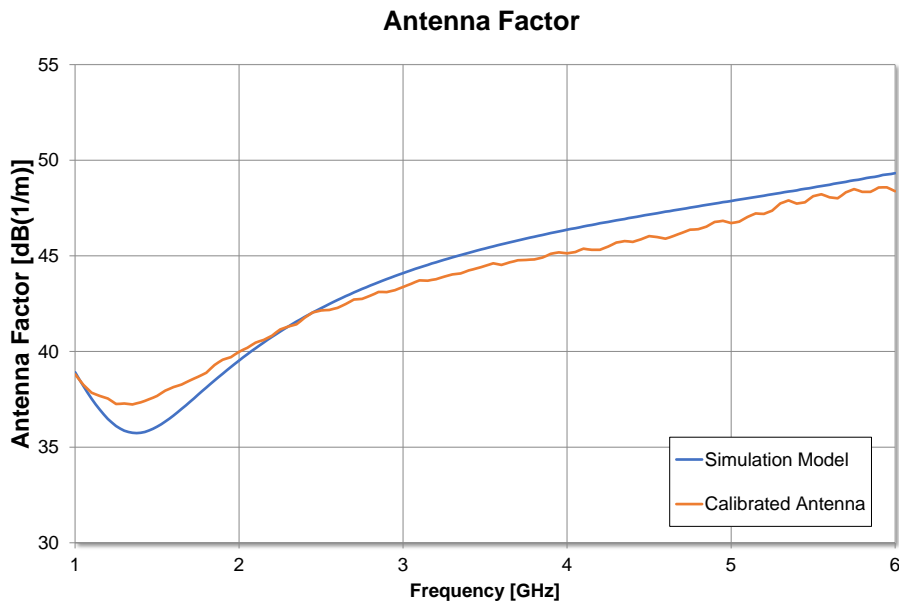

Figure 7: Simulated and measured antenna factor of transmit antenna

Figure 8 shows the simulation model of the validation setup described in Section 2.1. The green floor ground plane represents a perfect grounding. The 10 cm thick bonding strap at the back of the reference ground plane is connected to the floor ground plane as specified in CISPR 25 [1]. The near electric field is observed at a height of 1 m and a distance of 1 m from the dipole antenna. The simulation was conducted in horizontal and vertical polarization of the dipole antenna and the maxima field strength values were utilized for the modeled reference field strength.

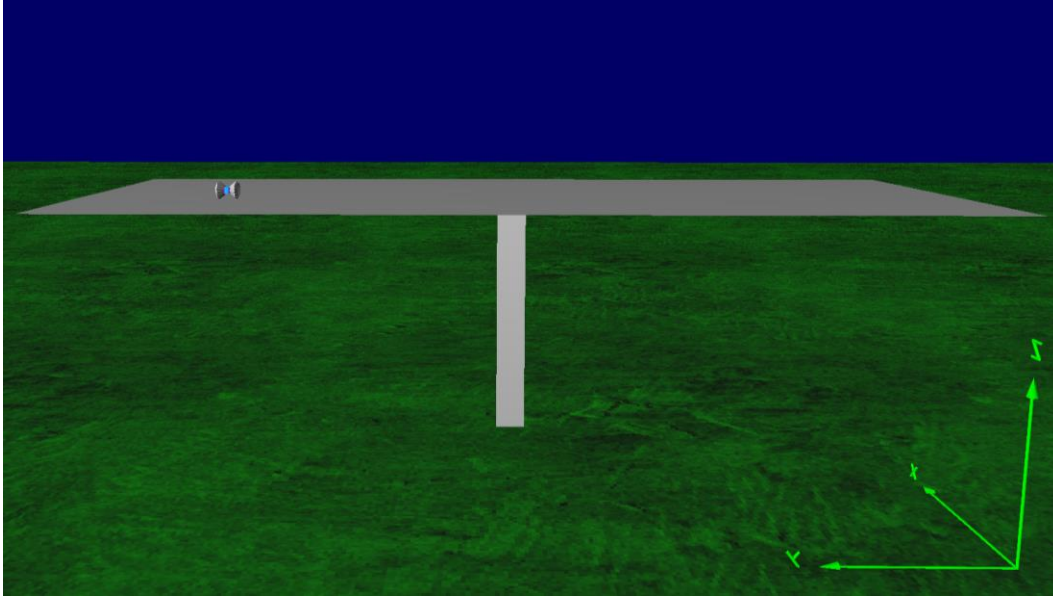

Figure 8: Simulation model of validation setup, horizontal antenna polarization

3.2 Measurement Uncertainty Simulation Method

The measurement uncertainty of the simulation method is calculated according to “Evaluation of measurement data – Guide to the expression of uncertainty in measurement” [5]. The measurand $\Delta E_{eq,max}$ is calculated by equation (2) and equation (3). The measurement uncertainty for the reference measurement method is not calculated.

$$E_{eq} = 120 + (M_A - M_0) + k_{AF} + (\delta A_{ANT} + \delta A_{CP} + \delta A_{CA} + \delta M_{TX} + \delta M_{RX} + \delta M_0 + \delta V_{SG}) \quad (2)$$

$$\Delta E_{eq,max} = E_{eq,max} - E_{eq,max,ref} \quad (3)$$

Table 1 shows the considered input quantities and the calculation of the expanded measurement uncertainty. Positioning of antennas and cables is estimated after a variety of tests. The mismatch values are calculated out of VSWR data for the used measurement equipment and attenuators. Receiver reading values are based on the values in CISPR 16-4-2 [6]. The antenna factor of the receive horn antenna is measured according to ARP 958 Rev E [7] and the uncertainty of the antenna factor is taken from the calibration certificate. The uncertainty of the simulation model results from the deviation between the measured and the simulated antenna factor.

Simulation Method Quantity x_i	Symbol	Uncertainty of x_i		$c_i u(x_i)$
		dB	Probability distribution function	
Positioning of antennas	δA_{ANT}	± 0.10	Rectangular	0.06
Positioning of cables	δA_{CP}	± 0.50	Rectangular	0.29
Stability cable attenuation	δA_{CA}	± 0.05	Rectangular	0.03
TX Mismatch	δM_{TX}	± 0.16	U-shaped	0.11
RX Mismatch	δM_{RX}	± 0.04	U-shaped	0.03
M_0 Mismatch	δM_0	± 0.01	U-shaped	0.01
Stability signal generator	δV_{SG}	± 0.05	k=1	0.05
M_A Receiver reading	M_A	± 0.10	k=1	0.10
M_0 Receiver reading	M_0	± 0.10	k=1	0.10
Antenna factor	k_{AF}	± 1.20	k=2	0.60
Simulation model	$E_{eq,max,ref}$	± 1.63	Rectangular	0.94
Expanded uncertainty (k=2)				2.34

Table 1 Measurement uncertainty calculation, simulation method

4 Results and Conclusion

Figure 9 shows the maximum equivalent field strengths at both test sites and the modeled reference field strength. Below 2 GHz the modeled reference field strength is higher than the equivalent field strengths observed by the measurements and above 2 GHz the modeled reference field strength is lower. This is caused, by the simulation model, because the actual measurements share almost the same course. Even if the course of the measured equivalent field strengths is similar, the curve observed in the ALSE has a higher ripple. This ripple is caused by the influence of the absorbers and the blank ferrite tiles. The test chamber is designed for consumer product testing and therefore just partially covered with hybrid absorbers behind the test table.

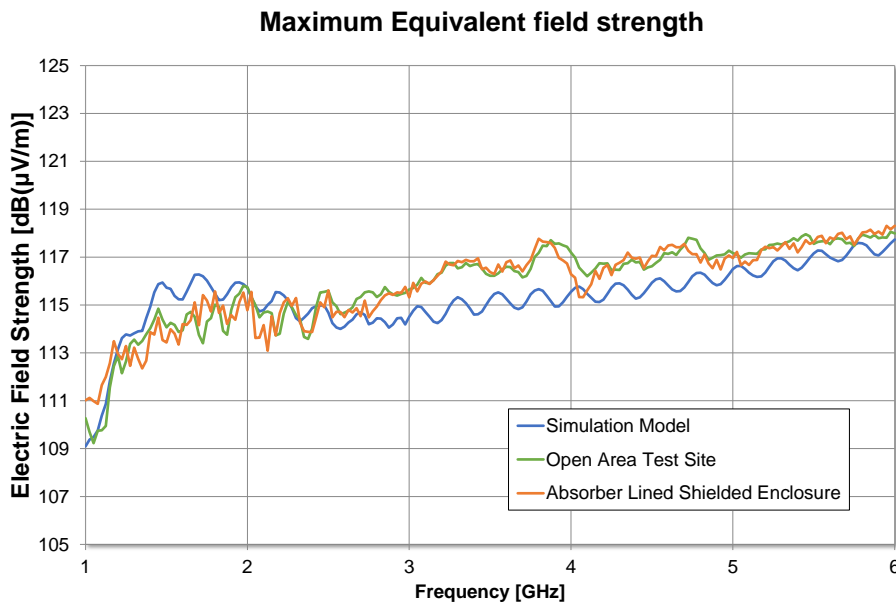

Figure 9: Maximum equivalent field strengths

Figure 10 displays the evaluation of the influence of the ALSE according to the simulation method and the reference measurement method. The results are obtained by subtracting the reference values from the measured equivalent field strength inside the ALSE. It is observable, that the simulation and the measurements match in respect to the ± 6 dB performance limit. The course of the simulation method shows a systematic behavior, caused by the simulation model, see Figure 9. On the other hand, the course of the reference measurement method is uniformly distributed over the whole frequency range, as expected.

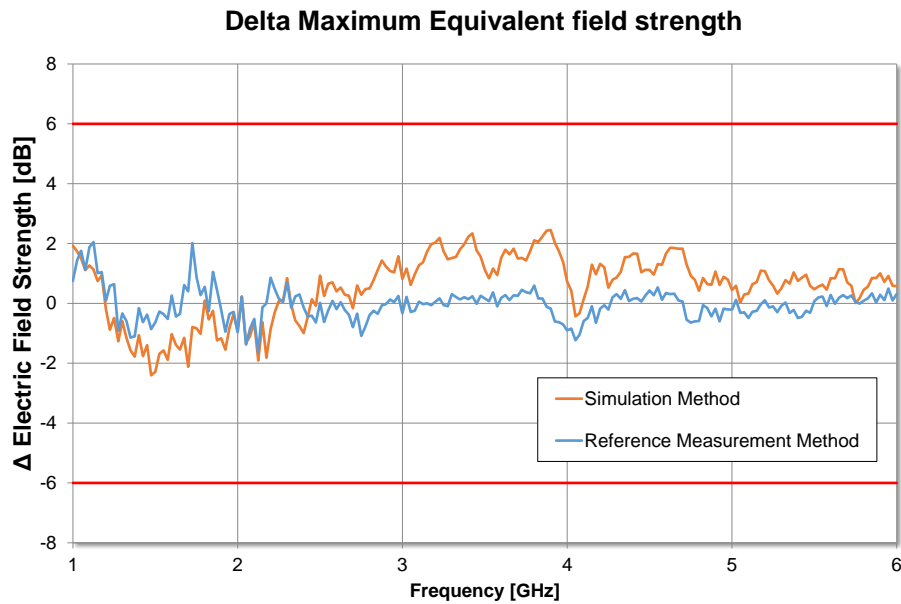

Figure 10: ALSE validation results according to both methods

Figure 10 illustrates, that the simulation method and the reference measurement method provide reasonable results and are applicable for ALSE validations. Both procedures can be expanded to higher frequency ranges by utilizing an appropriate dipole antenna. The reference measurement method is more accurate. On the other hand, it is less practical for laboratories because they must send their antenna pair periodically to a calibration laboratory for a new reference measurement.

Bibliography

- [1] CISPR 25, Ed. 5.0, *Vehicles, boats and internal combustion engines – Radio disturbance characteristics – Limits and methods of measurement for the protection of on-board receivers*, IEC, Geneva, Switzerland, Dec. 2021.
- [2] Seibersdorf Labor, "MANUAL POD – Precision Omnidirectional Dipole," 3.1 ed., rf.seibersdorf-laboratories.at, 14 Feb. 2011. [Online]. Available: https://rf.seibersdorf-laboratories.at/fileadmin/uploads/intranet/dateien/pod_manual_3.1_low_gesamt.pdf. [Accessed 22 December 2023].
- [3] A. Kriz and W. Müllner, "An Accurate Validation Procedure for Component Testing Chambers," *Compliance Engineering Nov/Dez 2002*, pp. 40, 2002.
- [4] P. D. Richeson, "NEC-2 Manual, Part III: User's Guide," nec2.org, 24 Sep. 1996. [Online]. Available: <http://www.nec2.org/other/nec2prt3.pdf>. [Accessed 11 January 2024].
- [5] BIPM et al., "Evaluation of measurement data - Guide to the expression of uncertainty in measurement," bipm.org, Sep. 2008. [Online]. Available: https://www.bipm.org/documents/20126/2071204/JCGM_100_2008_E.pdf/cb0ef43f-baa5-11cf-3f85-4dcd86f77bd6. [Accessed 11 January 2024].
- [6] CISPR 16-4-2:2011+A1:2014+A2:2018, Ed. 2.2, *Specification for radio disturbance and immunity measuring apparatus and methods - Part 4-2: Uncertainties, statistics and limit modelling - Measurement instrumentation uncertainty*, IEC, Geneva, Switzerland, Aug. 2018.
- [7] ARP 958, Rev. E, *Electromagnetic Interference Measurement Antennas; Calibration Method*, SAE INTERNATIONAL, Sep. 2021. doi: 10.4271/ARP958E